

Notice

- The information in this document is subject to change without notice. Every effort has been made in the preparation of this document to ensure accuracy of the contents, but all statements, information, and recommendations in this document do not constitute a warranty of any kind, expressed or implied.
- This item incorporates copy protection technology that is protected by U.S. patents and other intellectual property rights of Rovi Corporation.

Reverse engineering and disassembly are prohibited.









The figures in this document are for reference.

Contents

1 EC2108V5	1
Items in the Packaging Box	1
Appearance	2
Front Panel.....	2
Rear Panel.....	3
2 Infrared Remote Control.....	5
Function Description	5
Study Function.....	8
3 Using the STB for the First Time.....	10
Connecting Cables	10
Starting the STB	11
4 FAQs.....	12
5 Specifications	14

1 EC2108V5

Items in the Packaging Box



No.	Item		Quantity
1	Set Top Box (STB)		1
2	Infrared remote control		1
3	Battery		2
4	Power adapter		1
5	Audio/Video cable		1
6	RJ45 cable		1
7	High Definition Multimedia Interface (HDMI) cable		1
8	User Guide	-	1

Appearance



Front Panel









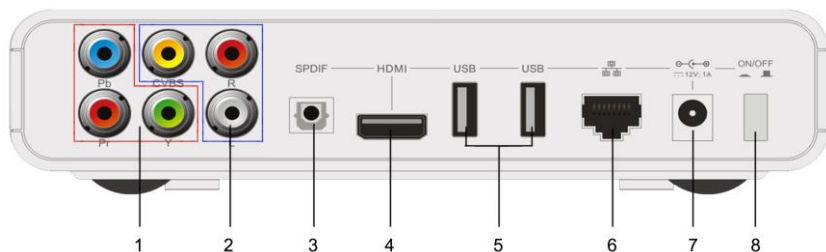



No.	Name	Description
1		Press it to switch STB between working state and standby state.
2		Power indicator. <ul style="list-style-type: none"> • If the indicator is in green, it indicates that the STB is in active mode. • If the indicator is in red, it indicates that the STB is in standby mode.
3		Link indicator. <ul style="list-style-type: none"> • If the indicator is in green, it indicates that the STB is connected to the network. • If the indicator is in red, it indicates that the STB is disconnected from the network.

4		Infrared indicator. If the indicator blinks, it indicates that the STB is receiving signals from the remote control.
---	---	---

Rear Panel











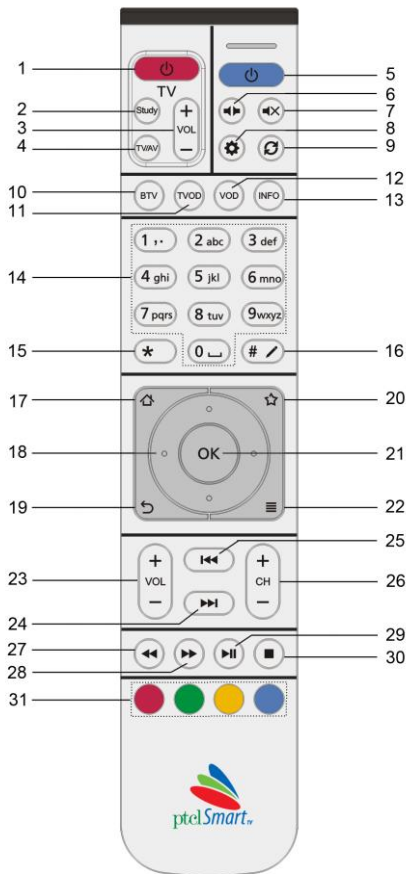









No.	Name	Description
1		They are connected to the Y, Pb, and Pr input ports of a TV set.
2		Port for connecting to the composite video input port of a TV.
		Port for connecting to the left audio channel input port of a TV.
		Port for connecting to the right audio channel input port of a TV.
3		Optical port for the output of digital audio, used for connecting to the optical port (for the input of digital audio) of a power amplifier.
4		HDMI output port.















No.	Name	Description
5		USB 2.0 port. Special functions can be added by using the USB 2.0 port to meet operation requirements.
6		10/100 Mbit/s Base-T Ethernet port for connecting to an Ethernet port on a wall or on an x digital subscriber line (xDSL) modem.
7		DC input port (12 V, 1 A).
8		Power switch.

2 Infrared Remote Control

Function Description



No.	Item	Description
1		Switch the status of TV Set between working and standby.
2		Study the function of the TV set's Remote control.
3		Change audio volume of TV set.
4		Shift video output of TV set.
5		Switch the status of STB between working and standby.
6		Change audio channel.
7		Mute/resume the audio.
8		Display the STB setting page.
9		Quickly switch to the previous channel.
10		Shortcut to Live TV channel list.
11		Shortcut to TVOD menu.
12		Shortcut to VOD menu.
13		Display information of current program.
14		Numerals 0 to 9 and associated letters.
15		Enter an asterisk (*).
16		<ul style="list-style-type: none"> • Enter a number sign (#). • Switch between input methods.
17		Shortcut to homepage.

No.	Item	Description
18		Move the cursor upward, downward, leftward or rightward in EPG.
19		Return to previous menu.
20		Reserved key (defined by EPG).
21		Confirm an operation.
22		Show more options menu.
23		Change audio volume of STB.
24		Turn to the next page.
25		Turn to the previous page.
26		Change channels of the STB.
27		Fast rewind a VOD or TSTV program.
28		Fast forward a VOD or TSTV program.
29		<ul style="list-style-type: none"> • Pause or resume program playback. • Adjust program playback progress.
30		Stop program playback.
31		Reserved Key (Defined by EPG).

NOTE

Certain keys (for example, keys related to the live service, TSTV service, or VOD service) are available only when a carrier provides related services. If the keys are unavailable, contact the carrier for service provisioning information.





Study Function

Overview

Your STB remote control is able to study the functions of keys on your TV remote control. This allows you to control both your STB and TV by using your STB remote control.

Only the keys on the TV study keypad on your STB remote control are used for studying the functions of keys on your TV remote control. The other keys on your STB remote control are used for controlling the STB.

There are four keys on the TV study keypad:

- : enables your STB remote control to enter the study mode.
- , , and : enable your STB remote control to study the functions of keys on your TV remote control.

The functions of all keys on your TV remote control can be studied. It is recommended that the functions of the keys on your TV remote control that have the same names as keys on your STB remote control be studied.

Procedure

Assume that you want your STB remote control to study the function of the Power key on your TV remote control. The procedure is as follows:

Step 1 Hold down  on the TV study keypad for 3 seconds.

The indicator on your STB remote control is steady on, which indicates that the STB has entered the study mode.

Step 2 Hold down  on the TV study keypad for 1 second.



The indicator on your STB remote control blinks, which indicates that your STB remote control is ready for receiving a signal.

Step 3 Aim the emission port of your TV remote control at the emission port of your STB remote control (the distance between the two ports must be less than 3 cm), and hold down the Power key on your TV remote control for 3 seconds to send a signal.

- If the indicator on your STB remote control quickly blinks three times and then is steady on, your STB remote control has received the signal and the study of the Power key function is complete. Release the Power key on your TV remote control.
- If the indicator on your STB remote control does not respond in the preceding way, your STB remote control has failed to receive the signal. Repeat steps 2 and 3.

 **NOTE**

You can repeat steps 2 and 3 to enable your STB remote control to study the

functions of the  and  keys on your TV remote control.

Step 4 Press  to save the settings and to exit the study mode.

After that, you can control your TV by using the  key on the TV study keypad.

Precautions

- If no signal is received within 10 seconds after your STB remote control enters the study mode, the study mode exits automatically.
- The keys on the TV study keypad can be used for studying the functions of keys on your TV remote controls of various brands. If your STB remote control has studied the functions of keys on your first TV remote control and then the functions of keys on your first TV remote control, you can control your second TV instead of your first TV by using your STB remote control.
- If you have trouble using your STB remote control to control your TV after performing steps 1 to 4, verify that your STB remote control is working properly.

3 Using the STB for the First Time

Connecting Cables

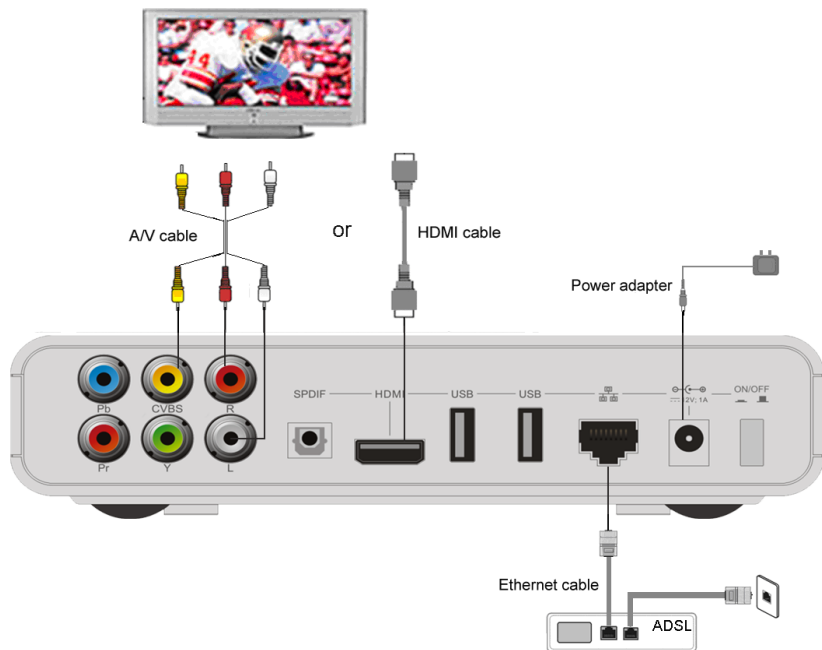

To connect cables, perform these steps:

Step 1 Select one of the following methods to connect the video cable:

1. Use the HDMI cable to connect the HDMI port of the STB to the HDMI input port of a TV. If the TV can decode audio received from the HDMI input port, skip step 2.
2. Use the video cable to connect the CVBS port of the STB to the video input ports of the TV.

- Step 2** Use the audio cable to connect the audio output ports (L and R ports) of the STB to the corresponding audio input ports of the TV.
- Step 3** Use the RJ45 cable to connect the Ethernet port of the STB to a 10/100 Mbit/s Base-T Ethernet port on a wall or an xDSL modem.
- Step 4** Insert the power plug of the STB into the power socket.



If degraded picture quality is observed while viewing copy-protected VOD movies connect the set-top box directly to the TV set. Do not connect through a VCR.

Starting the STB

To start the STB, perform these steps:

- Step 1** Turn on the TV, and change the TV signal input mode to a correct mode such as HDMI or AV.

For example, if the default TV signal input mode is HDMI and the STB is connected to the TV using an AV cable, you must adjust the TV signal input mode to AV.



The method of selecting the TV signal input mode varies according to TV vendor and model. For details, see the corresponding instructions in the TV user guide.

- Step 2** Turn on the power switch on the rear panel of the STB.

4 FAQs

Problem	Possible Cause	Solution
The STB indicators are off and the STB cannot be powered on after you press the power switch on the rear panel.	The STB is powered off.	Verify that the power cable is properly connected and the power switch on the rear panel is turned on.
		Verify that the power socket on a wall or the extension cord functions properly and that the socket is not blocked by something.
No video is displayed on the TV screen.	The video cable or network cable is not properly connected.	Verify that the video cable and network cable are properly connected. For details, see Connecting Cables .
	The STB is powered off.	Verify that the STB is powered on.
	The TV is in an incorrect mode.	Verify that the TV is in the correct mode. For details, see Starting the STB .
No audio is heard.	The audio cable is not properly connected.	Verify that the audio cable is properly connected. For details, see Connecting Cables .
	The TV or the STB is in mute mode or the volume is extremely low.	Switch the TV and STB to the audible mode, and increase the volume.
The remote control is working abnormally.	The remote control is far away from the STB.	Move the remote control to a workable distance.
	The batteries in the remote control are low.	Replace the batteries.

Problem	Possible Cause	Solution
No electronic program guide (EPG) page is displayed on the TV screen.	The network connection is abnormal.	Check the network connection. For details, see Connecting Cables.
	STB configuration is incorrect.	Reconfigure the STB.
Black-and-white images are displayed after STB startup.	The video cable is of poor quality or is not properly connected.	Replace and reconnect the video cable.



If a problem persists after you use the suggested solution or a problem is not described in this table, contact the carrier for help.

5 Specifications

Item	Specification
Input voltage	100–240 V AC, 50 Hz or 60 Hz
Power supply	external 12 V, 1 A DC power supply
Power consumption	< 10 W(excluding the power consumption of an external USB devices)
Environment requirements	Operating temperature: 0 °C to +40 °C (32 °F to 104 °F)
	Operating humidity: 10% to 90%
Dimensions (H x W x D)	44 mm x 180 mm x 125 mm (1.73 in. x 7.09 in. x 4.92 in.)
Weight	0.6 kg (1.32 lb)